

TYPICAL DETAIL - Permeable paving - 1/20 @A1

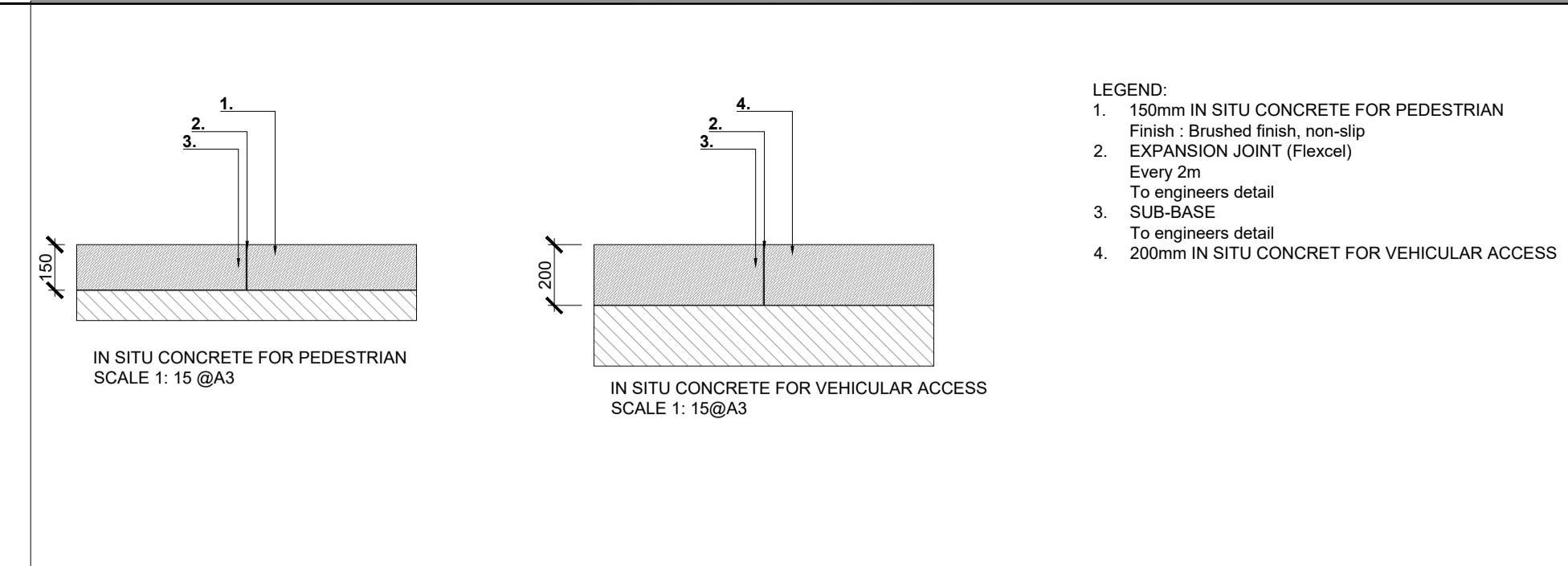

TYPICAL DETAIL - Brush concrete for footpath - 1/20 @A1

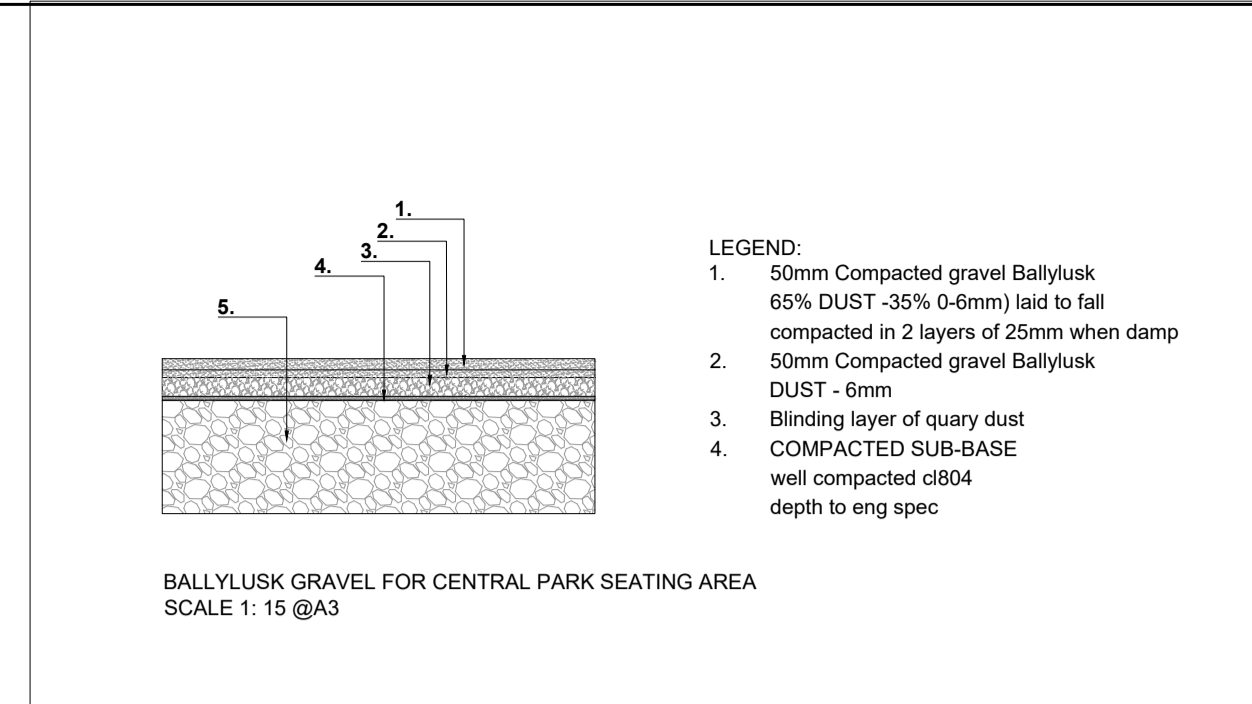

TYPICAL DETAIL - Ballylusk gravel - 1/20 @A1

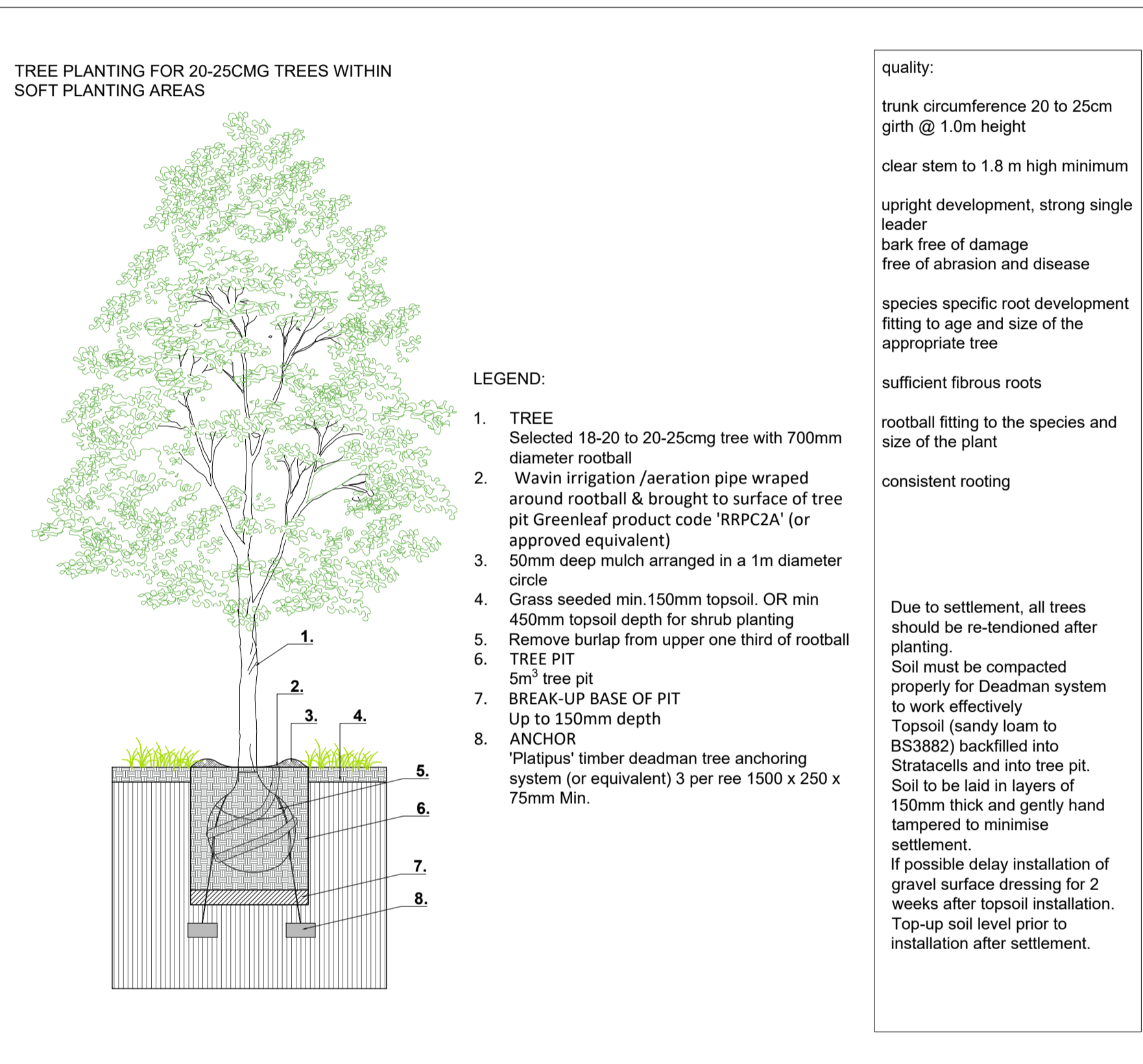

TYPICAL DETAIL - Tree planting - 1/50 @A1

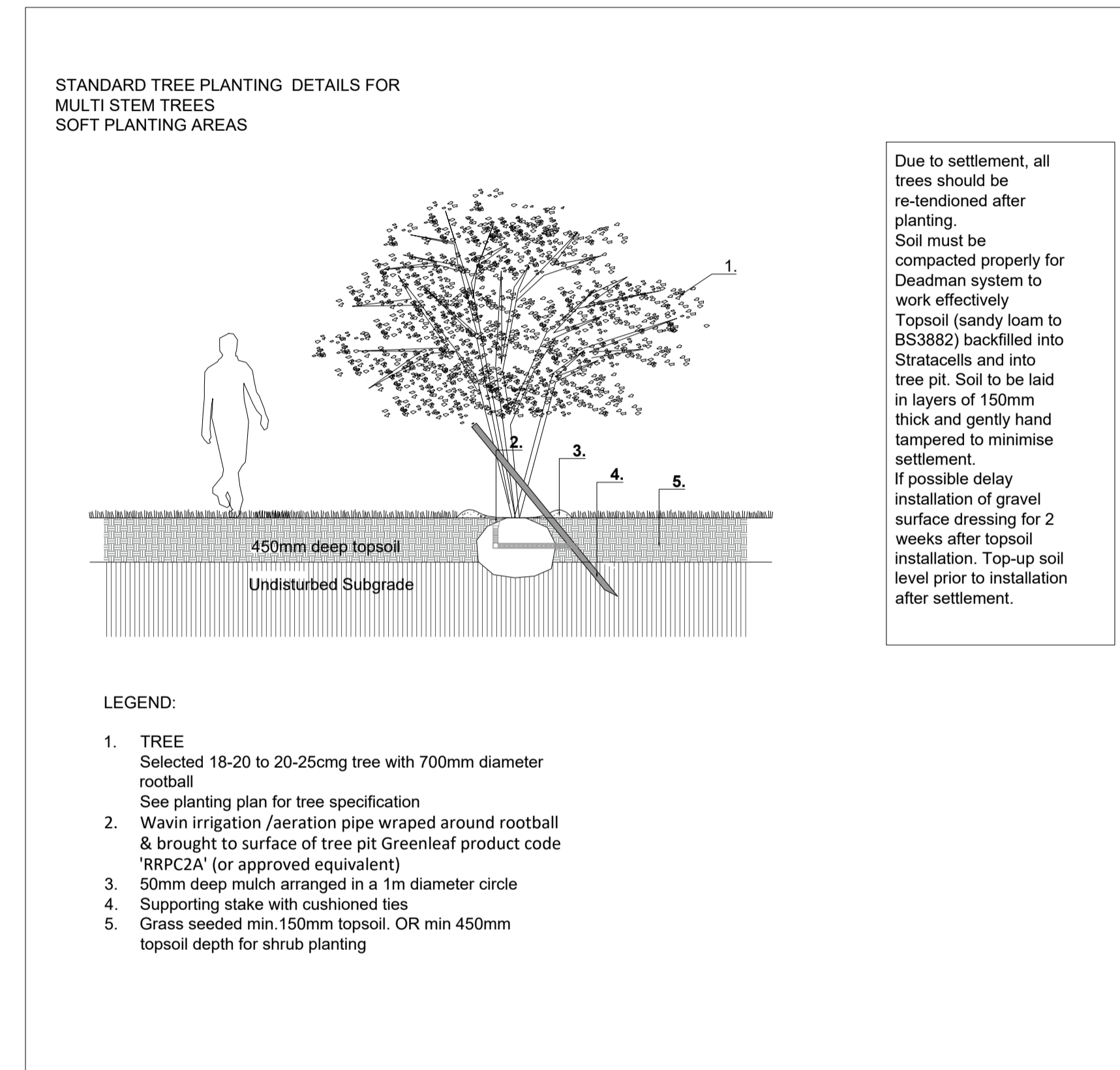

TYPICAL DETAIL - Multi stem tree planting - 1/50 @A1

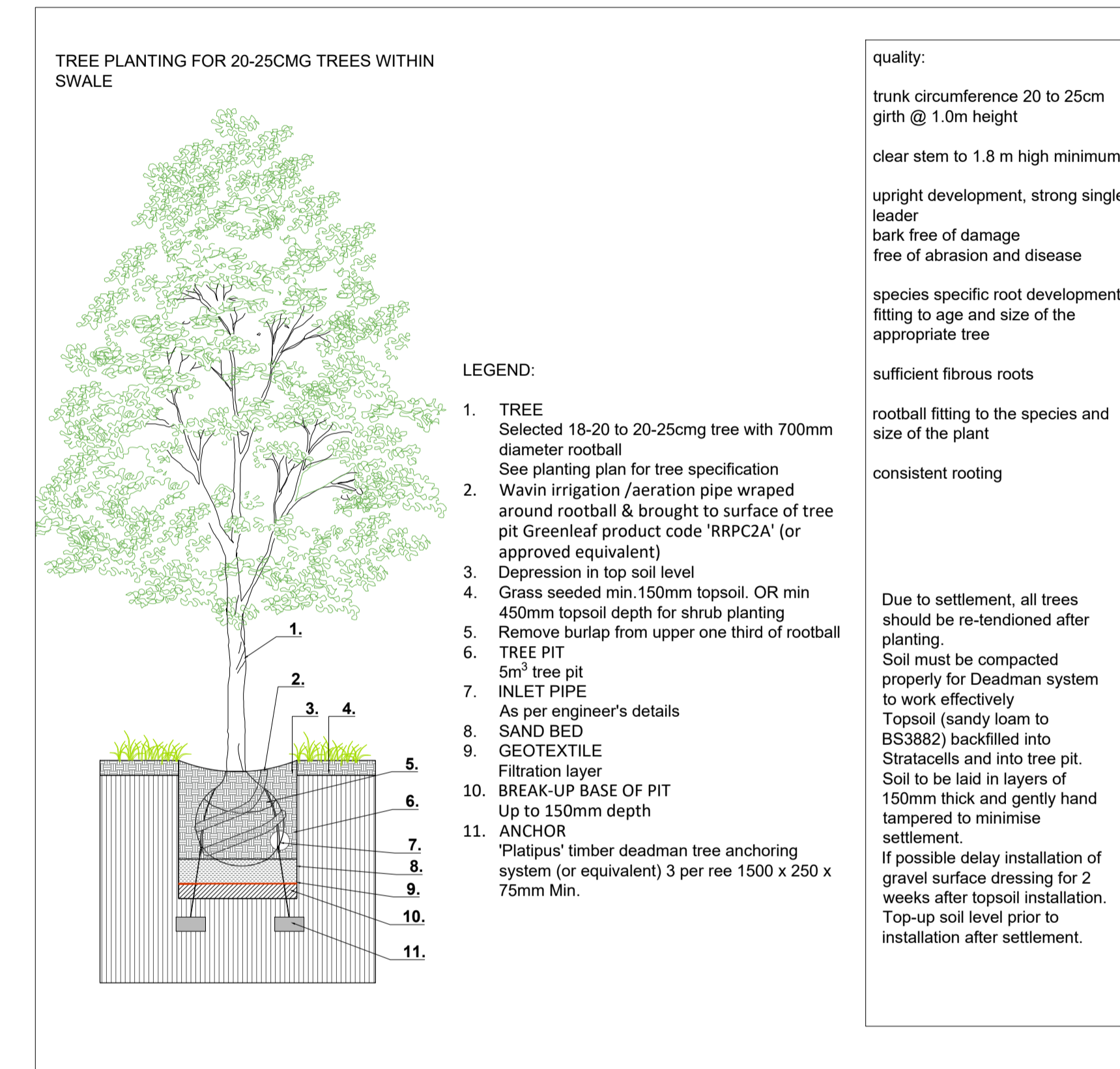

TYPICAL DETAIL - Bio retention tree pit - 1/50 @A1

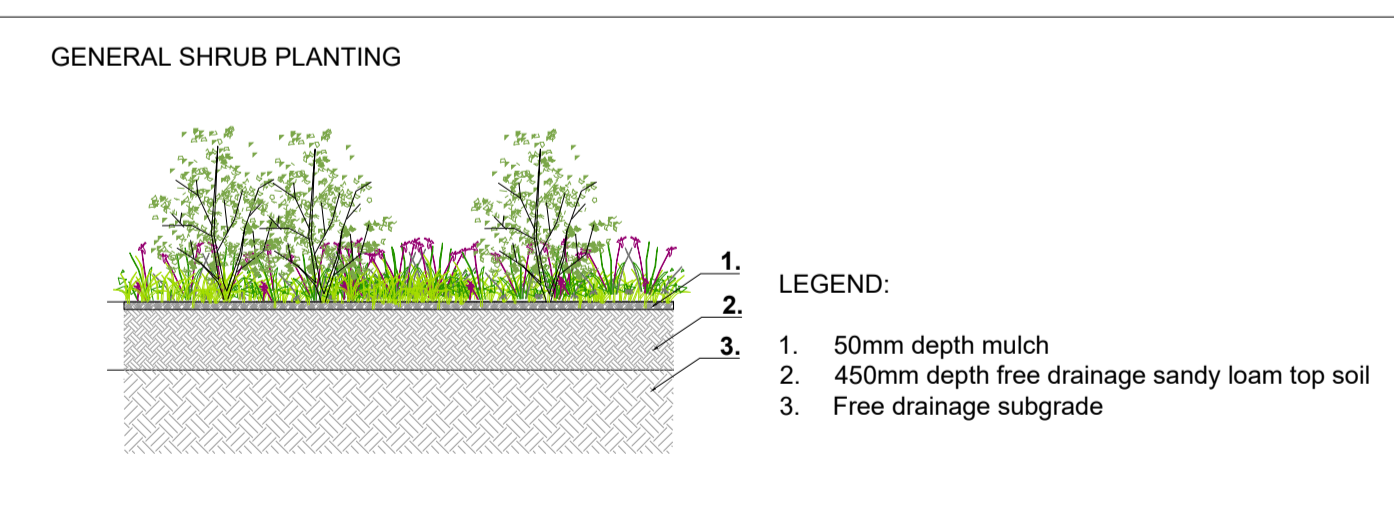

TYPICAL DETAIL - Shrub planting - 1/50 @A1

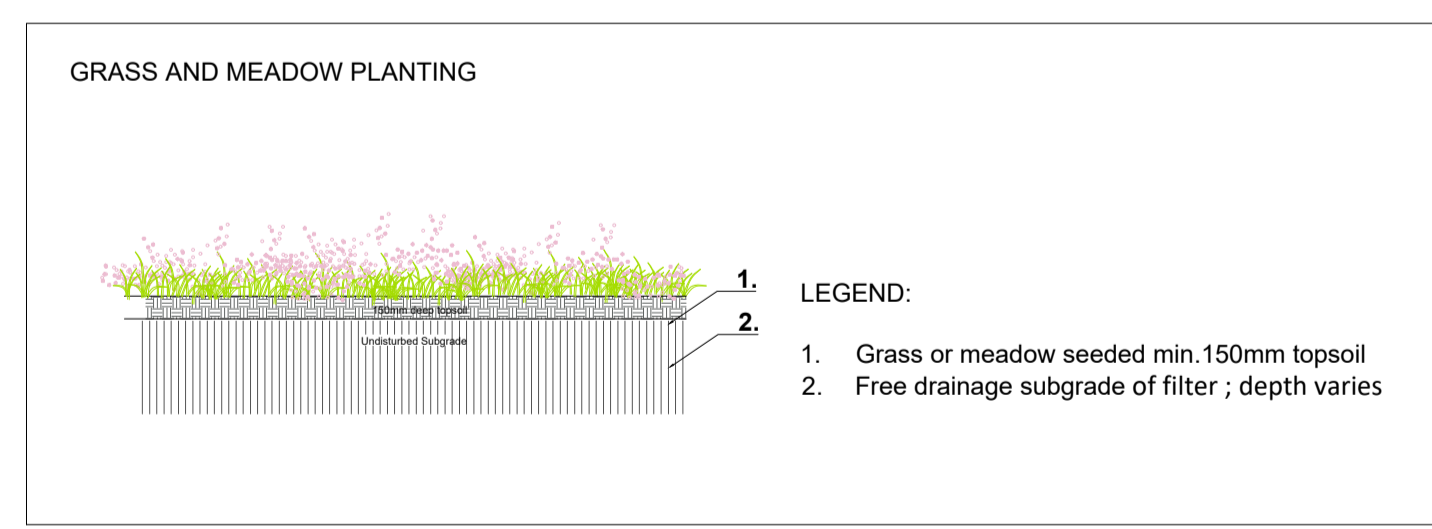

TYPICAL DETAIL - Grass and meadow planting - 1/50 @A1

LEGEND:

REV	DESCRIPTION	DATE
01	Issue for planning	28/06/2024

Mitchell + Associates

PROJECT TITLE:
 Social Housing Bundle 4 & 5
 CLIENT:
 NDA
 DRAWING NAME:
 Kishogue - Clonburris
 Hard surface and landscape typical details
 DRAWING NUMBER:
 300
 JOB NUMBER:
 LSOC003
 STATUS:
 PLANNING

DRAWN: CF
 CHECKED: FP
 SCALE: AS@ A1

NOTES:
 All dimensions are in millimeters unless otherwise stated and shall be checked and confirmed by the contractor on site. Any discrepancies shall be immediately reported to the landscape architects. Work to figured dimensions only. Do not scale from drawing. Do Not Scale. Use Figured Dimensions Only. Not for Construction Purposes unless Specifically Marked. © This Drawing is Copyright of Mitchell + Associates.

www.mitchell.ie info@mitchell.ie +353 1 454 5066